

RFID Basic Product Guide

CarePod™ Wall-Mounted Workstations that feature locks with a basic RFID card reader can accommodate up to twenty (20) User RFID Cards and a maximum of six (6) Manager Keys (or Manager RFID Cards) which provide management access and external power. Programming is accomplished via a single (1) yellow Programming Key which is unique to your lock system/facility. If your facility already uses Digilock locks, your existing black Manager Keys and yellow Programming Key can be used with your new CarePod locks.

Lock Orientation

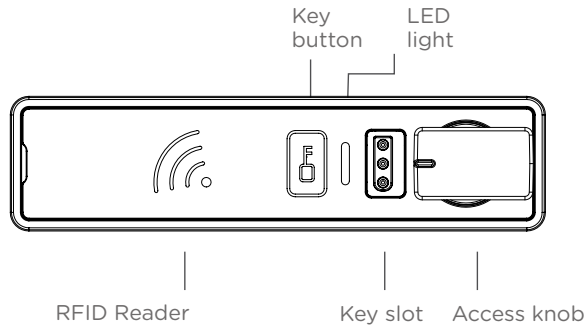

Works with RFID iClass and Mifare 13.56 MHz*



RFID cards



Mifare stickers

*Confirm your facility's card compatibility prior to purchase with a Carstens sales rep

Keys



Manager Key¹

Programming Key²

	Manager Key ¹	Programming Key ²
Operates the lock	•	•
Overrides user access	•	•
Allows management inspection	•	•
Provides external power	•	•
Programs Manager Keys to the lock		•
Assigns user credentials ³	•	
Sets lock functionality		•



If your facility already uses Digilock locks, your existing yellow Programming Key can be used to program your new CarePod locks. Existing black Manager Keys can also be utilized.

¹ Up to six (6) black Manager Keys may be programmed to each lock

² One (1) yellow Programming Key allowed per lock system

³ Up to 20 unique users may be assigned to each lock

Key Insertion

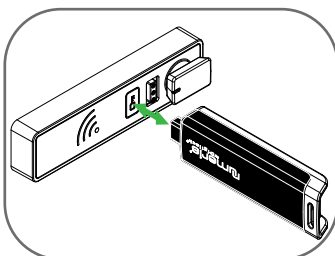

The colored side of the key must face towards the keypad.

Step 1 - Programming Keys

Locks are shipped with factory default settings (only operates by touching ). Each lock must be set up with one (1) yellow Programming Key and up to six (6) black Manager Keys or Manager RFID Cards. **Only one (1) yellow Programming Key can be used per facility lock system.**

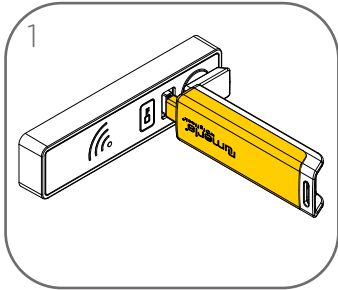

1
Insert the yellow Programming Key.
A two-tone beep will sound and the LED will flash.

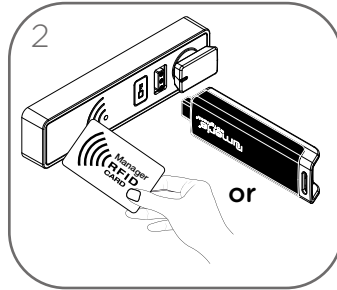

2
While the LED is flashing, insert one (1) black Manager Key or touch and hold one (1) Manager RFID Card to the reader at a time.
A two-tone beep will sound for each Manager Key or RFID Card programmed.

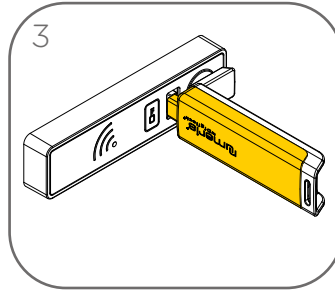

3
Insert the yellow Programming Key again.
A two-tone beep will sound and the LED will turn off.
The Programming Key and Manager Keys/RFID Cards are now programmed.

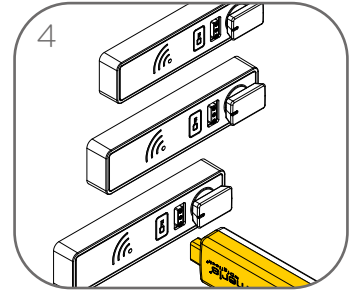



4
Repeat these steps for each lock or follow instructions to [Express Register Manager Keys \(Optional Step 3\)](#) to pair all locks in your CarePod™ system with your yellow Programming Key and black Manager Keys/RFID Cards.

Step 2 - Programming RFID Cards

Assign User RFID Cards

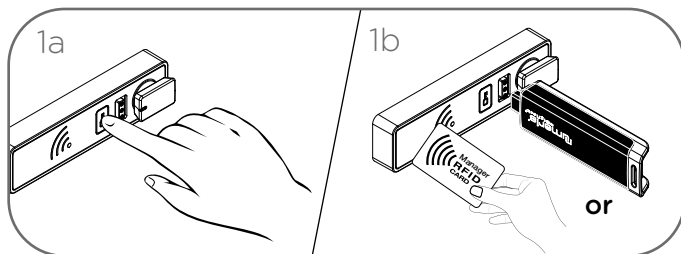
Each basic RFID lock can be programmed to work with up to 20 assigned User RFID Cards. To program User RFID Cards, follow the steps below. Please read the steps prior to attempting to program a RFID Card. Once you begin the programming sequence, you only have 10 seconds before the process times out and you'll have to start over.



1a
Press and hold  for 5 seconds (a two-tone beep will sound) then release.
The LED will flash.
While the LED is flashing, insert a valid black Manager Key or a valid Manager RFID Card.
A two-tone beep will sound and the LED will turn on.

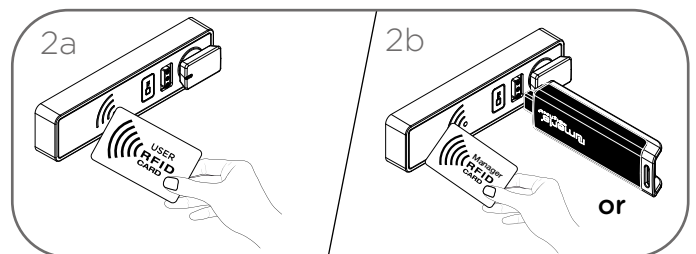

2a
While the LED is on, touch and hold each User RFID Card one at a time.
A two-tone beep will sound for each User RFID Card successfully programmed.
To end programming, insert a valid black Manager Key or touch and hold a valid Manager RFID Card. Two sets of two-tone beeps will sound and the LED light will turn off.

Optional Step 3 - Express Register Multiple Locks

Express Register User RFID Cards and Manager Keys/RFID Cards

Once configured, the yellow Programming Key can quickly program multiple locks to operate with the same User RFID Cards, allowing multiple CarePod™ workstations to share users and access.

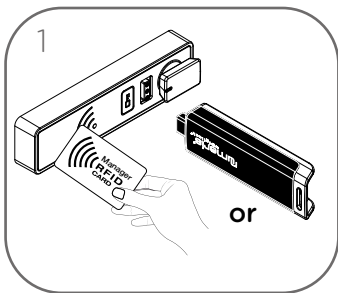

Go to a lock already programmed to operate with the user and manager credentials.

Touch and hold  for 15 seconds. After 5 seconds, a two-tone beep will sound. After 10 seconds, two sets of two-tone beeps will sound. After 15 seconds, three sets of two-tone beeps will sound.

Release the hold and the LED will start to flash.

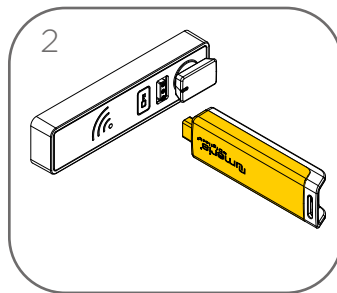

While the LED is flashing, insert the yellow Programming Key. A two-tone beep will sound and the LED will turn off.

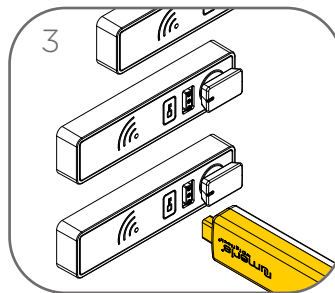

Insert the yellow Programming Key to program each lock to operate with the same User RFID Cards and black Manager Keys or Manager RFID Cards.

Two sets of two-tone beeps will sound and the LED will flash twice to indicate successful programming.

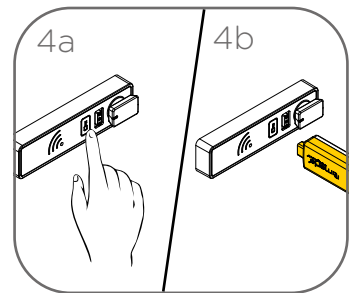

End Express Registration mode:*

Go to any programmed lock. Touch  and then insert the yellow Programming Key.

*The yellow Programming Key will continue to function in Express Registration mode until it is used to operate a lock.

Operating Instructions

Once programmed, CarePod™ locks can be operated with assigned User/Manager RFID Cards or black Manager Keys.

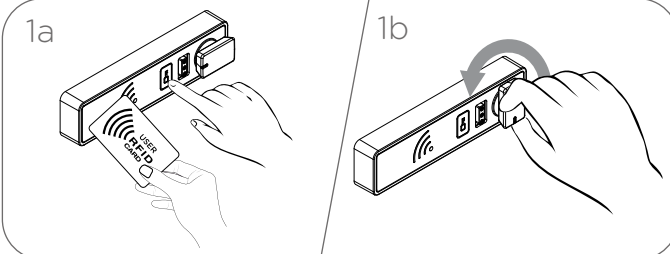

Operate with a RFID Card

To unlock: Touch  and touch and hold any valid User or Manager RFID Card, then turn the knob to the unlocked position. Open the CarePod door.†

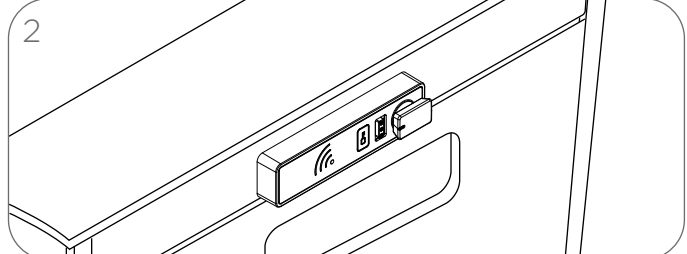

To lock: Simply close the CarePod door.

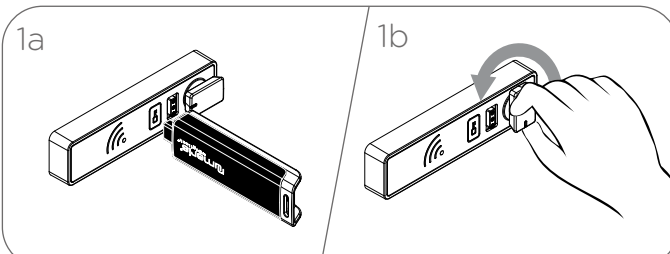

Operate with a Manager Key

To unlock: Insert a valid black Manager Key, then turn the knob to the unlocked position. Open the CarePod door.†

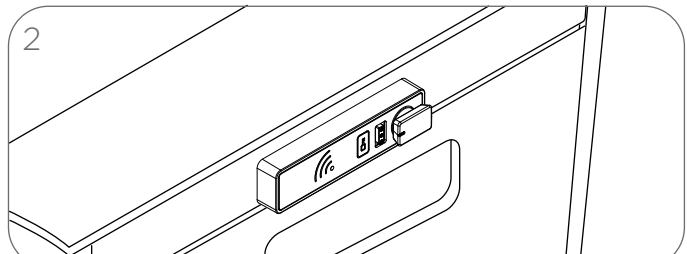

To lock: Simply close the CarePod door.

†The lock will remain in the locked position if the knob is not turned within approximately six seconds.

Adding Additional Manager Keys or RFID Cards

Additional black Manager Keys or Manager RFID Cards can be programmed to the locks at any time. Each lock can support up to of six (6) managers.

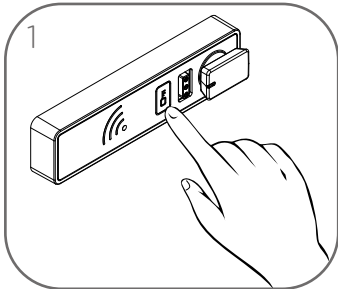

Go to a lock requiring a manager.

Touch and hold **M** for 5 seconds (a two-tone beep will sound after 5 seconds) then release.

The LED will flash.

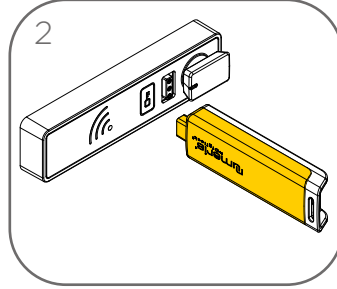

While the LED is flashing, insert the yellow Programming Key.

A two-tone beep will sound.

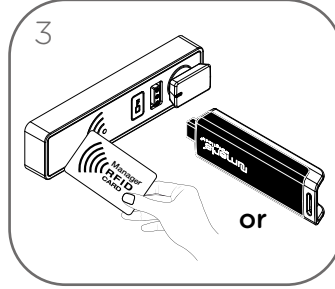

While the LED is flashing, insert each additional black Manager Key or touch and hold each RFID Manager Card, one at a time.

A beep will sound for each Manager Key or Manager RFID Card programmed.

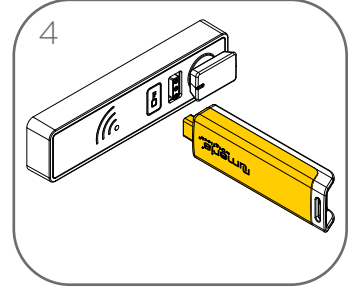

Insert the yellow Programming Key. A two-tone beep will sound and the LED will turn off.

Repeat these steps for each lock or follow instructions to [Express Register Managers \(Optional Step 3\)](#) to quickly program multiple locks to operate with the same black Manager Keys or Manager RFID Cards.

Replacing Manager Keys and/or Manager RFID Cards

The locks must be reprogrammed to remove a black Manager Key or Manager RFID Card from operating a lock. **Caution: The following steps will remove ALL managers from the locks and you will have to reprogram each Manager Key or Manager RFID Card to each lock. We suggest only doing this in the event loss/theft.**

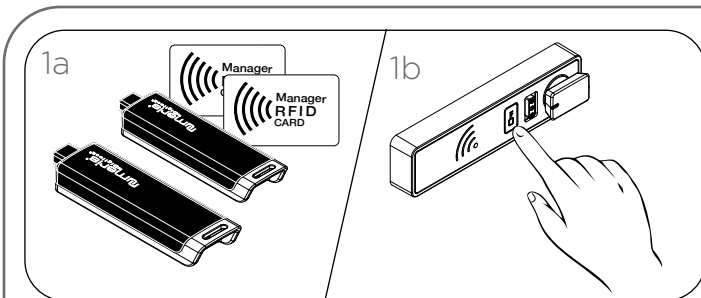

Collect all remaining and replacement Manager Keys/RFID Cards.

Go to any lock operated by the lost/stolen Manager Keys/RFID Cards.

Touch and hold **M** for 5 seconds (a two-tone beep will sound) then release.

The LED will flash.

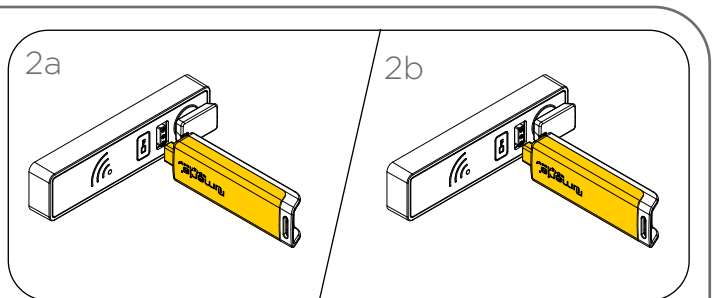

While the LED is flashing, insert the yellow Programming Key. A two-tone beep will sound.

Insert the yellow Programming Key again.

Three sets of two-tone beeps will be heard and the LED will turn off. All previously programmed Manager Keys/RFID Cards will be erased.

Follow instructions to [Add Manager Keys or RFID Cards](#) to program the remaining and replacement Manager Keys/RFID Cards to the locks.

Removing User RFID Cards

The locks must be reprogrammed to remove all User RFID Cards from operating a lock. **Caution: The following steps will remove ALL User RFID Cards from the locks and you will have to reprogram each lock. We suggest only doing this in the event loss/theft.**

1

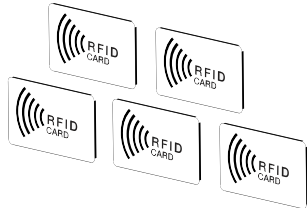

Removing All User RFID Cards

Collect all remaining User RFID Cards including any replacements.

2a

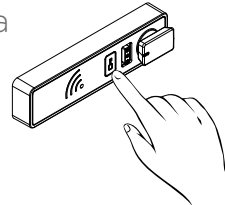

2b

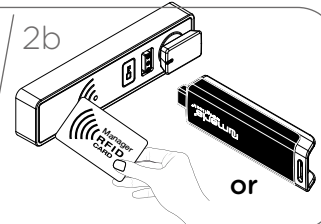

Touch and hold **07** for 5 seconds (a two-tone beep will sound after 5 seconds) then release.

The LED will start to flash.

While the LED is flashing, insert a valid black Manager Key or touch and hold a valid Manager RFID Card.

A two-tone beep will sound.

3

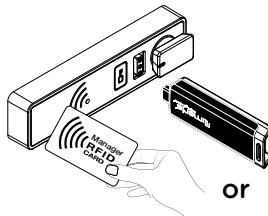

Insert the black Manager Key or touch and hold the Manager RFID Card again.

Three sets of two-tone beeps will sound and the LED will turn off. All previously assigned User Codes will be removed.

4



Follow [Step 2 - Programming User Cards](#) instructions to assign the remaining and replacement User RFID Cards to the locks.

Replacing the Yellow Programming Key

CarePod™ Basic RFID locks can be programmed to only one (1) yellow Programming Key. In the event of loss/theft of the yellow Programming Key, the locks must be reprogrammed to prevent unwanted individuals from operating a lock.

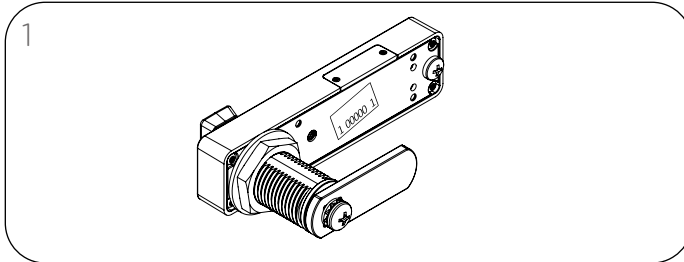

Note the order or serial number (found on the rear of the lock). You'll need this number when calling Digilock Support.



Contact Digilock Support at 1-800-989-0201 and select Option 3. Digilock Support will help facilitate the purchase of a replacement yellow Programming Key.

Support is available M-F 7:00 am to 5:00 pm PST.

Battery Replacement*

When the battery needs to be replaced, it is not necessary to remove the lock from the CarePod.*

CAUTION: There is a risk of explosion or leakage if battery is replaced by an incorrect type, mixed with a different battery type, or inserted backwards. Replace all batteries of a set at the same time. Be sure to insert batteries with correct polarities. Remove depleted batteries from the product promptly and dispose of used batteries according to the battery manufacturer's instructions.

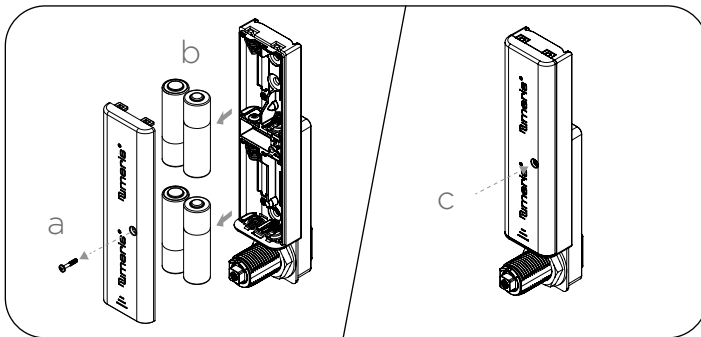

- a Remove the screws and the battery cover.
- b Replace the four (4) premium AA batteries.
- c Replace battery cover and screws.

*In case of battery failure, operate with a valid black Manager Key or yellow Programming Key. Both key types supply external power to open the locks.

Support

Low Battery Indicator

After locking or unlocking, the lock emits two sets of three beeps indicating that the batteries are low. Replace the batteries.

Does Not Unlock with the User RFID Card

The lock does not recognize the card. For immediate access, operate with a valid black Manager Key or Manager RFID Card. Follow instructions to [Assign User Cards](#) to assign a new User RFID Card to the lock.

Does Not Operate with a Black Manager Key or Manager RFID Card

The lock does not recognize the Manager Key/RFID Card. Follow instructions to [Add Managers](#) to program the Manager Key or Manager RFID Card to the lock. For immediate access, operate with another valid black Manager Key or Manager RFID Card.

Does Not Operate with the Yellow Programming Key

The lock does not recognize the yellow Programming Key. If the Programming Key has been replaced, operate with the replacement Programming Key. Contact Digilock Support for additional assistance.

No Audible Feedback When Is Touched

The batteries may need to be replaced. For immediate access, operate with a valid black Manager Key or Manager RFID Card. If the error condition persists, replace the batteries.

Technical Support

Monday – Friday, 7:00 am to 5:00 pm PST

Call 1-800-989-0201 and select Option 3

When calling for product troubleshooting or warranty support, please have your lock serial number, your black Manager Key(s), and yellow Programming Key available (if possible), and be in front of the lock that is not functioning correctly.

For non-urgent needs, email support@digilock.com

2-Year Limited Warranty

LIMITED WARRANTY. Security People Inc. dba Digilock (Company) warrants to the original purchaser of Product manufactured by Company to be free of defects in material and workmanship, provided: (1) Company has been notified of such defects within two years of purchase date and been given the opportunity of inspection by return of any alleged defective Product to Company, or its authorized distributor, free and clear of liens, encumbrances, transportation prepaid, accompanied by the statement of defects and proof of purchase; and (2) Product has not been subject to modification, abuse, misuse, mishandling, misapplication, neglect (including but not limited to improper maintenance), accident, improper installation, alteration and/or modification (including but not limited to use of unauthorized parts or attachments), disassembly, or adjustment or repair performed by anyone other than authorized service personnel during such period; and (3) such defect has not been caused by corrosion or ordinary wear and tear.

This warranty does not cover batteries, normal wear and tear of parts and/or damage resulting from any of the following: negligent use or misuse of product, use of improper voltage or current, and/or use contrary to operating instructions. The exclusive remedy shall not be deemed to have failed of its essential purpose so long as Company is willing and able to repair or replace non-conforming Product in the prescribed manner.

Unless otherwise expressed by Company on the sales order acknowledgement, Product is not designed or intended for exterior use or where exposed to moisture. Any use where Product is exposed to moisture is not covered by any warranties and voids any warranties and any resulting damage caused by direct exterior exposure or moisture is at the Buyer's own risk.

The liability of Company for any breach of the foregoing warranty shall not extend to dismantling, installing or reinstalling, but shall be limited to repairing or replacing said items, as Company's option, within a reasonable time after receipt of written notice from Buyer, within the period of time stipulated herein, of any such non-conforming Product, provided that (i) such notice is given immediately upon the detection of such non-conformance and (ii) such notice is received within the time period stipulated herein. BUYER AND COMPANY EXPRESSLY AGREE THAT THE BUYER'S SOLE AND EXCLUSIVE REMEDY AGAINST COMPANY SHALL BE FOR THE REPAIR OR REPLACEMENT (AT COMPANY'S OPTION) OF NON-CONFORMING PRODUCT AS PROVIDED HEREIN.

COMPANY SPECIFICALLY DISCLAIMS ANY OTHER WARRANTIES, EXPRESS, IMPLIED, OR STATUTORY, INCLUDING WITHOUT LIMITATION THE IMPLIED WARRANTY OF FITNESS FOR A PARTICULAR PURPOSE AND THE IMPLIED WARRANTY OF MERCHANTABILITY, AND COMPANY ALSO SPECIFICALLY DISCLAIMS ANY LIABILITY FOR CONSEQUENTIAL OR INCIDENTAL DAMAGES. IN NO EVENT SHALL COMPANY BE LIABLE FOR INCIDENTAL OR CONSEQUENTIAL DAMAGES ARISING OUT OF OR IN CONNECTION WITH THIS AGREEMENT (INCLUDING BUT NOT LIMITED TO BREACH OF ANY OBLIGATION IMPOSED ON COMPANY HEREUNDER OR IN CONNECTION HERewith) OR THE USE, STORAGE, DISPOSAL OR HANDLING OF PRODUCT. Consequential damages for purposes hereof shall include, without limitation, loss of use, income or profit, shutdown, slowdown or stoppage of any production line or facility, or losses sustained as the result of injury (including death) to any person, or loss of or damage to property (including without limitation property handled or processed by the use of Product). Buyer shall indemnify Company against all liability, cost or expense which may be sustained by Company on account of any such loss, damage or injury.

Company will not evaluate warranted Product without Buyer obtaining a Return Merchandise Authorization (RMA) number from Company. Such returns must be prominently marked with the RMA number and shipped prepaid.

Company makes no other warranty, and the warranty is limited to the duration of the expressed warranty period as set forth above.

NOTE: Should Product be considered a consumer product as may be covered by the Magnusson Moss Federal Warranty Act, please be advised that:

(1) some states do not allow limitations on incidental consequential damages or how long an implied warranty lasts so that the above limitations may not fully apply; (2) this warranty gives specific legal rights, and a buyer may also have other rights which may vary from state to state.

LIMITATION OF LIABILITY. Company's maximum liability for any damages resulting from or caused by Product, whether in contract, tort, or otherwise, is limited to the purchase price of Product. In no event shall Company be liable for any consequential damages of any nature arising from the sale or use of Product, whether in contract, tort or otherwise, by either use or purchase of Product, the user or purchaser agrees to this limit on Company's liability. Company is not responsible for any modification, addition or alteration to Product by others.

Company reserves the right to make changes in designs and specifications or to make additions or improvements on its products without notice and without incurring any obligation to incorporate them on products previously manufactured.